

JVC

SERVICE MANUAL

STEREO RECEIVER

MODEL **R-X350VB**



Contents

Safety Precautions	1-1	5. Block Diagram	1-9
1. Specifications	1-2	Parts List	Separate-volume Insertion
2. Names of Parts and Their Functions	1-3	6. R-X350VB Schematic Diagram	
3. Removal Procedures		6-(1) R-X350VB Tuner Section	1-10
3-(1) Removing the Front Panel	1-6	6-(2) R-X350VB Amplifier Section	1-11
3-(2) Removing the Tuner P.C. Board	1-6	7. Servicing Method for AWG #20	
3-(3) Removing the Equalizer P.C. Board	1-6	Wires with Clamping Terminals	1-13
3-(4) Removing the Amplifier P.C. Board	1-6	8. Handling Precautions of LCD Panels	back cover
3-(5) Removing the S.E.A. Control P.C. Board	1-6		
3-(6) Removing the Power Amplifier P.C. Board	1-6		
4. Adjustment Procedures			
4-(1) FM/AM Tuner	1-7		
4-(2) Power Amplifier Idling Current	1-8		

Safety Precautions

1. The design of this product contains special hardware, many circuits and components specially for safety purposes.

For continued protection, no changes should be made to the original design unless authorized in writing by the manufacturer. Replacement parts must be identical to those used in the original circuits. Service should be performed by qualified personnel only.

2. Alterations of the design or circuitry of the product should not be made. Any design alterations or additions will void the manufacturer's warranty and will further relieve the manufacturer of responsibility for personal injury or property damage resulting therefrom.

3. Many electrical and mechanical parts in the product have special safety-related characteristics. These characteristics are often not evident from visual inspection nor can the protection afforded by them necessarily be obtained by using replacement components rated for higher voltage, wattage, etc. Replacement parts which have these special safety characteristics are identified in the parts list of Service manual. Electrical components having such features are identified by shading on the schematics and by (Δ) on the parts list in Service manual. The use of a substitute replacement which does not have the same safety characteristics as the recommended replacement part shown in the parts list in Service manual may create shock, fire, or other hazards.

4. The leads in the products are routed and dressed with ties, clamps, tubings, barriers and/or the like to be separated from live parts, high temperature parts, moving parts and/or sharp edges for the prevention of electric shock and fire hazard.

When service is required, the original lead routing and dress should be observed, and they should be confirmed to be returned to normal, after re-assembling.

5. To confirm the polarity of the power cord and AC outlet.

When replacing the power cord or the AC outlet, make sure that the power switch or the protection device (the primary fuse etc.) is NOT connected to the ground power side of the plug and AC outlet (wider blade of plug or wider hole of the AC outlet).

6. Leakage current check

(Safety for electrical shock hazard)

After re-assembling the product, always perform an isolation check on the exposed metal parts of the Products (antenna terminals, knobs, metal cabinet, screw heads, headphone jack, control shafts, etc.) to be sure the product is safe to operate without danger of electrical shock.

Do not use a line isolation transformer during this check.

- Plug the AC line cord directly into the AC outlet. Using a "Leakage Current Tester", measure the leakage current from each exposed metal part of the cabinet, particularly any exposed metal part having a return path to the chassis, to a known good earth ground. Any leakage current must not exceed 0.5 mA AC (r.m.s.).

- Alternate check method.

Plug the AC line cord directly into the AC outlet. Use an AC voltmeter having 1,000 ohms per volt or more sensitivity in the following manner. Connect a 1500 Ω 10 W resistor paralleled by a 0.15 μ F AC-type capacitor between an exposed metal part and a known good earth ground.

Measure the AC voltage across the resistor with the AC voltmeter.

Move the resistor connection to each exposed metal part, particularly any exposed metal part having a return path to the chassis, and measure the AC voltage across the resistor. Now, reverse the plug in the AC outlet and repeat each measurement. Any voltage measured must not exceed 0.75 V AC (r.m.s.). This corresponds to 0.5 mA AC (r.m.s.).

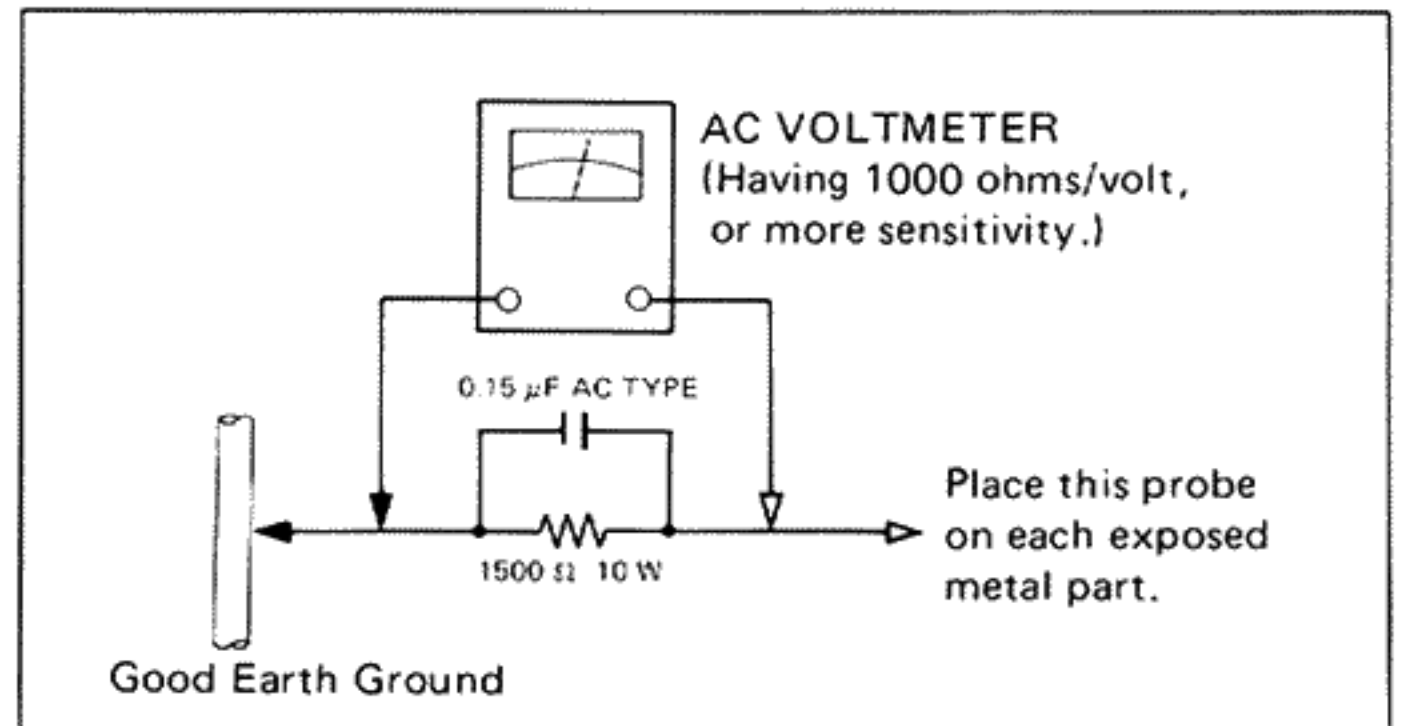

CHECKING YOUR LINE VOLTAGE (Except for U.S.A., Canada, Australia, U.K. and Continental Europe.)

Before inserting the power plug, please check this setting to see that it corresponds with the line voltage in your area. If it doesn't, be sure to adjust the voltage selector switch to the proper setting before operating this equipment. The voltage selector switch is located on the rear panel.

CAUTION Before selecting the "Voltage selector switch" to proper voltage disconnect the power plug.

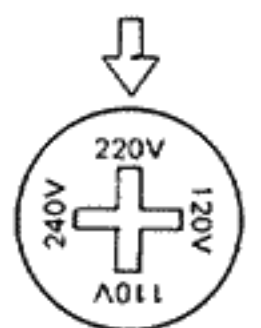

1. Specifications

AMPLIFIER SECTION

RMS Power : 55 watts per channel, min. RMS, both channels driven, into 8 ohms from 20 Hz to 20 kHz, with no more than 0.007 % total harmonic distortion.

60 watts per channel, min. RMS, both channels driven, into 8 ohms from 40 Hz to 20 kHz, with no more than 0.2 % total harmonic distortion.

58 watts per channel, min. RMS, both channels driven, into 8 ohms at 1 kHz with no more than 0.003 % total harmonic distortion.

60 watts per channel, min. RMS, both channels driven, into 8 ohms at 1 kHz with no more than 0.7 % total harmonic distortion.

Total Harmonic Distortion	: 0.003 % at 58 watts (1 kHz, 8 ohms)
Intermodulation Distortion	: 0.007 % at 55 watts
Damping Factor	: 45 at 8 ohms, 1 kHz
Input Sensitivity/Impedance	
PHONO	: 2.5 mV/47 kohms
TAPE PLAY, VTR, VIDEO-1/DAD, VIDEO-2/AUX	: 190 mV/40 kohms
Recording Output Level	: 190 mV
Frequency Response	
PHONO (RIAA Equalization)	: 20 Hz – 20 kHz, +1 dB, -1 dB
TAPE PLAY, VTR, VIDEO-1/DAD, VIDEO-2/AUX	: 5 Hz – 50 kHz, +0 dB, -1 dB
S.E.A. Graphic Equalizer	
Center frequencies	: 63 Hz, 250 Hz, 1 kHz, 4 kHz, 16 kHz
Control range	: ± 12 dB
Loudness Control (Volume control at -30 dB position)	: +6 dB at 100 Hz +4 dB at 10 kHz
Signal to Noise Ratio	
PHONO	: 71 dB ('66 IHF) 66 dB (DIN) 78 dB ('78 IHF, Rec out)
TAPE PLAY, VTR, VIDEO-1/DAD, VIDEO-2/AUX	: 100 dB ('66 IHF) 67 dB (DIN) 77 dB ('78 IHF)

FM TUNER SECTION

	'78 IHF	DIN (for Europe)
Tuning Range	: 87.9 MHz–107.9 MHz	87.5 MHz–108.0 MHz
Usable Sensitivity	: Mono 10.3 dBf (0.9 μV/75 ohms) (1.8 μV/300 ohms)	(S/N 26 dB) 1 μV/75 ohms 2 μV/300 ohms
50 dB Quieting sensitivity	: Mono 14.8 dBf (1.5 μV/75 ohms) (3.0 μV/300 ohms) Stereo 38.3 dBf (22.5 μV/75 ohms) (45 μV/300 ohms)	
S/N 46 dB Stereo Sensitivity	: —	Stereo 23 μV/75 ohms Stereo 46 μV/300 ohms
Signal to Noise Ratio (at 98 MHz, 80 dBf)	: Mono 82 dB Stereo 73 dB (A-net.)	Mono 74 dB Stereo 65 dB (weighted)
Total Harmonic Distortion	: Mono 0.08 % 1 kHz Stereo 0.15 %	Mono 0.1 % Stereo 0.3 %
Frequency Response	: 30 Hz – 15 kHz, +0.5 dB, -3 dB	
Capture Ratio	: 1.5 dB	1.0 dB
Alternate Channel Selectivity	: 60 dB, ±400 kHz	55 dB, ±300 kHz
Image Response Ratio	: 56 dB at 98 MHz	
IF Response Ratio	: 85 dB at 98 MHz	
Stereo Separation	: 45 dB at 1 kHz	40 dB at 1 kHz

AM TUNER SECTION

MW	'78 IHF	DIN (for Europe)
Tuning Range		
Channel space 9 kHz	: 522 kHz–1611kHz	522 kHz–1611 kHz
Channel space 10 kHz	: 530 kHz–1710 kHz	
Sensitivity	: 250 μV/m at 1000 kHz 30 μV at 1000 kHz	250 μV/m at 999 kHz 30 μV at 999 kHz
Signal to Noise Ratio (100mV/m)	: 50 dB at 1000 kHz	50 dB at 999 kHz
Selectivity	: 38 dB, ±10 kHz at 1000 kHz	35 dB, ±9 kHz at 999 kHz
Image Response Ratio	: 40 dB at 1000 kHz	40 dB at 999 kHz
IF Response Ratio	: —	55 dB
Total Harmonic Distortion (100mV/m)	: 0.5 % at 1000 kHz	0.5 % at 999 kHz

Design and specifications subject to change without notice.

VIDEO SECTION

Signal Allowable Input (VIDEO-1/VIDEO-2/VTR IN)	: 1.5 Vp-p
Output Signal Level (VTR OUT)	: 1 Vp-p (at 1 Vp-p input)
Impedance	: 75 ohms unbalanced
Synchronization	: Negative
S/N	: 45 dB
Crosstalk	: 45 dB (3.58 MHz)

Power Specifications

Areas	Line Voltage & Frequency	Power Consumption
U.S.A., Canada	AC 120 V, 60 Hz	250 watts, 310 VA
Continental Europe	AC 220 V~, 50 Hz	150 watts
U.K., Australia	AC 240 V~, 50 Hz	150 watts
Other Areas	AC 110/120/220/240 V~, Selectable, 50/60 Hz	180 watts

Dimensions and Weight

Dimensions			Weight
Height	Width	Depth	Net
117 mm (4-5/8")	435 mm (17-1/8")	341 mm (13-7/16")	6.8 kg (15.0 lbs)

2. Names of Parts and Their Functions

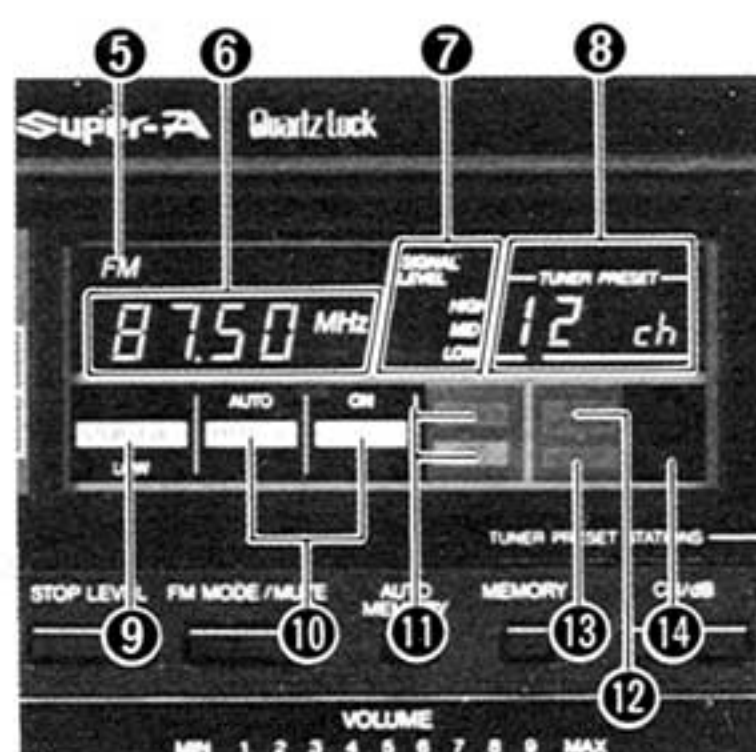
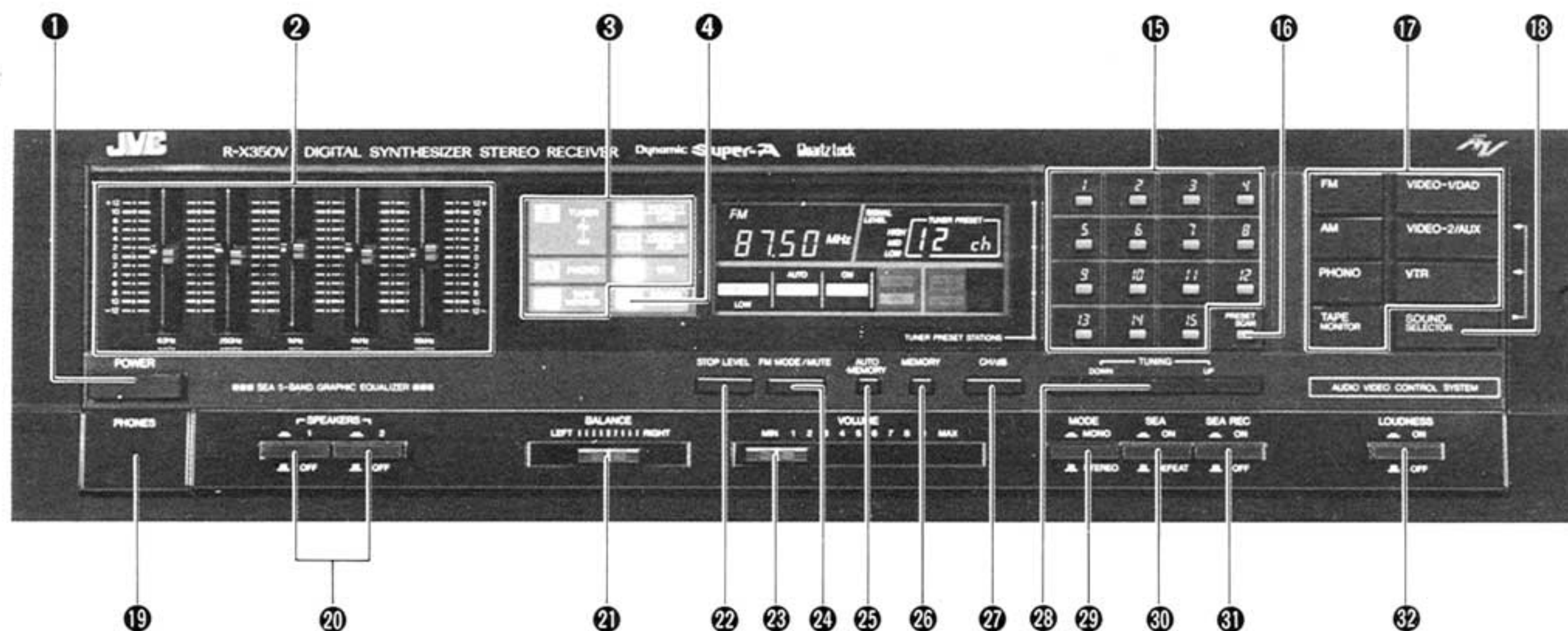

Note

- AUDIO** : For connection of audio signal.
VIDEO : For connection of video signal.

❶ POWER switch

Press to turn the power on. To turn the power off, press this again.

Note:

- An electronic source selector is used in this unit. When the POWER switch is first switched on, two or more sources or no source may be selected. Make sure to input the source select data by pressing one of the source selectors.

❷ S.E.A. Graphic Equalizer system

These five controls allow you to boost or lower response separately in five bands of the frequency spectrum by 12 dB. For operation of these controls, which give far more flexible control over tone than the conventional bass/treble controls. The small knob located on the left of each control can be slid together with control. Move the controls together with the knobs as required and then, when performing the next setting, move only the controls so that the knobs are left where they were. When the controls are moved back to the knobs, the previous setting is easily obtained.

❸ Pictorial source display

This lights according to the source selected.

❹ SOUND SELECTOR indicator

Lights when the SOUND SELECTOR switch is set to on.

❺ FM/AM indicator

FM is displayed during FM reception and AM during AM reception.

❻ Frequency indicator

The tuned-in frequency is displayed digitally. Four digits (kHz) are displayed during AM reception and five digits (MHz) (for Europe, U.K., Australia and other countries) or four digits (MHz) (for U.S.A. and Canada) are displayed during FM reception.

❼ SIGNAL LEVEL indicator

This is used in tuning to both FM and AM broadcasts. The signal strength is shown at three levels.

Note:

- Three levels – low, mid and high, corresponding to the signal strength in dB as shown below.

	LOW	MID	HIGH
FM	10 – 35 dB	40 – 55 dB	More than 60 dB
AM	40 – 65 dB	70 – 85 dB	More than 90 dB

❽ SIGNAL STRENGTH/ TUNER PRESET indicator

This indicator doubles as the dB signal strength indicator and the tuner preset indicator to show the channel number of the preset station.

This indicator can be switched between the two display modes by pressing the CH/DB switch.

Notes:

- 0 dB corresponds to 1 $\mu\text{V}/75$ ohms in FM and 1 $\mu\text{V}/\text{m}$ in AM.
- The indication is shown in 5 dB steps.
- The optimum signal strength is more than 40 dB for FM mono, more than 60 dB for FM stereo and 70 dB for AM. If the signal is too weak or too strong, this display may not indicate the correct value.
- Even if the dB display mode is set by pressing the CH/dB switch, the CH indication is displayed and maintained when the station select buttons are pressed. When the TUNING button is pressed, the 0 dB indication is displayed.
- If a broadcast is received by preset tuning and then the CH/dB switch is pressed so that the dB indication is displayed before switching the power off, the CH indication will be displayed when the power is switched on again.

9 STOP LEVEL indicator

This indicator shows HIGH or LOW according to the setting of the STOP LEVEL switch.

10 FM MODE/FM MUTE indicator

This indicator shows AUTO/ON or MONO/OFF according to the setting of the FM MODE/MUTE switch.

11 STEREO/QSC indicator

STEREO: When an FM stereo broadcast is being received, this indicator lights. When the MODE indicator shows MONO even if an FM stereo broadcast is received, this indicator will not light; press the FM MODE/MUTE switch so that AUTO is shown.

QSC: When a signal strength of an FM stereo broadcast is low, this indicator lights and the QSC (Quieting Slope Control) circuit is switched on to reduce noise.

Note:

- Since the STEREO and QSC is automatically set according to the signal strength, if the signal strength changes, re-tune.

12 AUTO MEMORY indicator

Lights when the AUTO MEMORY switch is set to on.

13 MEMORY indicator

Lights for about 5 seconds when the MEMORY switch is pressed to on or for 1 second when the frequency is stored in memory during auto memory.

14 PRESET SCAN indicator

Lights when the PRESET SCAN switch is pressed to on.

15 Station select buttons

These buttons are used to select one of the preset stations or to store the frequency in the memory of an individual channel. When one of these buttons is pressed, the channel number is shown by the TUNER PRESET indicator.

If one of these buttons is pressed when the MEMORY switch is pressed in, the frequency which is being received will be stored in memory.

Each of the station select buttons can be used in common for one FM station and one AM station.

If you change the mode from radio reception to any other mode including power-off and back to radio reception, the station previously selected with the station select buttons is tuned to again.

16 PRESET SCAN switch

This switch permits the scanning of the preset stations. When this switch is pressed, the PRESET SCAN indicator lights and channel 1 is tuned in then this channel number flashes for about 5 seconds. The following channels are shown in the same way. When the desired station is received, pressing this switch stops scanning so the R-X350VB remains tuned to the station. After 15 stations (each for the FM and AM bands) have been scanned, the frequency received originally before preset scanning is tuned to.

17 Source selector

FM switch: Press to switch on the FM tuner section.

AM switch: Press to switch on the AM tuner section.

PHONO switch: Press to listen to records on a turntable connected to the PHONO terminals.

TAPE MONITOR switch: Press to listen to the tape deck connected to the TAPE terminals.

VIDEO-1/DAD switch: Press to watch and listen to the source connected to the VIDEO-1/DAD terminals.

VIDEO-2/AUX switch: Press to watch and listen to the source connected to the VIDEO/AUX terminals.

VTR switch: Press to watch and listen to the VTR (Video Tape Recorder) deck connected to the VTR terminals.*

Note:

- The function of the source selector is changed by the setting of the SOUND SELECTOR switch 18. In this section, the function of the source selector with the SOUND SELECTOR set to OFF (with the SOUND SELECTOR indicator 4 not lit) is shown.

(1) The VIDEO-1/DAD, VIDEO-2/AUX or VTR switch has a function to select **AUDIO** and **VIDEO** at the same time.

(2) When the VTR and TAPE MONITOR switches are set to OFF.

The FM, AM, PHONO, VIDEO-1/DAD or VIDEO-2/AUX switch can select the corresponding source and the source selected is shown by the pictorial source display 3.

(3) In condition (2), with the TAPE MONITOR switch pressed to ON, tape is played back and with the VTR switch pressed to ON, the VTR is played. When both TAPE MONITOR and VTR switches are pressed, the VTR has priority and is played back.

The settings of both switches are shown by the pictorial source display 3.

In this case, the pictorial source display shows one of the FM, AM, PHONO, VIDEO-1/DAD and VIDEO-2/AUX sources.

(4) To set the VTR or TAPE MONITOR switch to OFF, press it again; its indicator in the pictorial display goes off.

(5) When FM, AM or PHONO switch is selected, the **VIDEO** signal is not output to the **VIDEO** MONITOR OUT terminal.

(6) When the VIDEO-1/DAD or VIDEO-2/AUX terminals are used only for **AUDIO** the **VIDEO** signal is not output to the **VIDEO** MONITOR OUT terminal.

18 SOUND SELECTOR switch

When the **VIDEO** signal of the VIDEO-2 or VTR is played back, if this switch is pressed to ON (the SOUND SELECTOR indicator 4 is lit), the **AUDIO** signal can be selected from a different source.

This SOUND SELECTOR switch has no effect on VIDEO-1.







(1) When the VTR is set to OFF and the SOUND SELECTOR switch is set to ON: The **VIDEO** signal from the VIDEO-2 terminal is output to the **VIDEO** MONITOR OUT terminal and the **VIDEO** VTR REC terminal.

When a source selector switch other than the VIDEO-2/DAD switch is pressed to set it to on, the source selected is heard from the speakers. (The **VIDEO** signal is output from the VIDEO-2 terminal.)

In this setting, when the VTR is in the recording mode, the **VIDEO** signal from the VIDEO-2 and the **AUDIO** signal from the source selected including the TAPE MONITOR switch are recorded.

(2) When the VTR switch is set to ON and the SOUND SELECTOR switch is set to ON.

The **VIDEO** signal from the VTR is output from the **VIDEO** MONITOR OUT terminal and any **AUDIO** signal selected except that from the VTR can be output.

- 19 Headphone jack (PHONES)**
Flip down the cover and plug stereo headphones into this jack for private listening and recording monitoring. If you want to listen to sound from the headphones only, press the SPEAKERS switches to OFF.
- 20 SPEAKERS switches**
SPEAKERS-1 switch
Press to switch the speakers connected to the SPEAKERS system 1 terminals on or off.
SPEAKERS-2 switch
Press to switch the speakers connected to the SPEAKERS system 2 terminals on or off.
- 21 BALANCE control**
Use to adjust the balance between the left and right speakers.
- 22 STOP LEVEL switch**
This is used to switch over the sensitivity of the receiver between high and low; this determines the strength of broadcast signals at which the scan tuning stops. It is effective during the auto memory and auto tuning.
Note:
• This stop level is related to the SIGNAL LEVEL indicator 7. The HIGH stop level corresponds to higher than MID level and the LOW stop level corresponds to LOW level.
- 23 VOLUME control**
Slide to the right to increase the sound level.
- 24 FM MODE/MUTE switch**
Press this switch so that AUTO of FM MODE and ON of FM MUTE light in the display for normal FM reception for automatic elimination of interstation noise.
When receiving a weak or noisy FM stereo of FM MODE and OFF of FM MUTE in the display light; the broadcast will be heard in mono but the clarity of reception will be improved.
- 25 AUTO MEMORY switch**
Press this switch to scan and preset broadcasts automatically. The dB indication is shown and the received frequency changes from the lower frequency limit. After this, if a broadcast is tuned in, its signal strength is shown in dB for 1 second and channel number 1 flickers for 3 seconds. If this broadcast is not required to be stored in memory, press this switch within 4 seconds; the dB indication is shown and auto memory function starts again. If not, the MEMORY indicator and channel number light together and its frequency is stored in the memory of channel number 1. Then the dB indication is shown again and upscanning restarts. The same function is performed for the remaining channels.
When the frequency reached to upper limit, the auto memory function stops and the channel number in which the highest frequency is stored in memory is shown. If there is no broadcast to be tuned to, the upper limit frequency is shown with dB displayed instead of the channel number. When all channel memories have frequencies stored in them, the last frequency is tuned to and its channel number is shown. During this operation, if any of the band switches is pressed, this function stops and the broadcast being heard is still received if its band is the same as that of the switch pressed while the last channel is tuned to if its band is different from the switch pressed.
Note:
• Do not press the PRESET SCAN switch during auto memory for stable operation.
Do not perform the auto memory function when the source selector is set to other than TUNER.
- 26 MEMORY switch**
Press this switch and the MEMORY indicator will light to show that it is ready to receive a memory setting. Pressing the station select button while the MEMORY indicator is lit (for about 5 seconds) makes it possible to store the station in the specified memory. At this time, the channel number is shown in the display.
- 27 CH/dB switch**
Press to select the channel indication of dB indication. If one of the station select buttons is not pressed beforehand, only the dB indication is shown and this switch has no effect. During auto memory and preset scanning, this switch does not work.
- 28 TUNING UP/DOWN button**
When this button is pressed, the dB indication is shown.
DOWN: Press to tune to lower frequencies.
UP: Press to tune to higher frequencies.
Manual tuning
Tapping these sides changes the frequency in single steps of 9 or 10 kHz in AM or 50 or 100 kHz in FM.
Auto tuning
Holding either side of button pressed for more than 0.5 second and then releasing it starts auto tuning; when a broadcast is received, tuning will stop. But if either side of button is kept held in, scanning continues even when a broadcast is received. In auto tuning, pressing either side of button again stops scanning.
Note:
• Tapping the button stops changing the frequency when the upper or lower frequency is reached, while, in auto tuning the frequency changes in the opposite direction.
- 29 MODE switch**
STEREO (): To listen to stereo sound from a stereo source. Normally set this switch to this position.
MONO (): In this position, the left and right channel signals are mixed and reproduced from both speakers.
Note:
• When the VTR connected is not a stereo model, press this switch to set to MONO () to output the same sound from both speakers. Otherwise, sound will be output only from one speaker.
- 30 SEA switch**
DEFEAT (): To bypass the SEA circuit. Convenient for checking the SEA-compensated signal and for comparison with the uncompensated sound.
ON (): Use this position for normal SEA compensation.
- 31 SEA REC switch**
Press to ON () to record tapes with the added effect of the S.E.A. Graphic Equalizer.
- 32 LOUDNESS switch**
Press this switch to ON () to compensate for the ear's lower sensitivity at low listening levels.

3. Removal Procedures

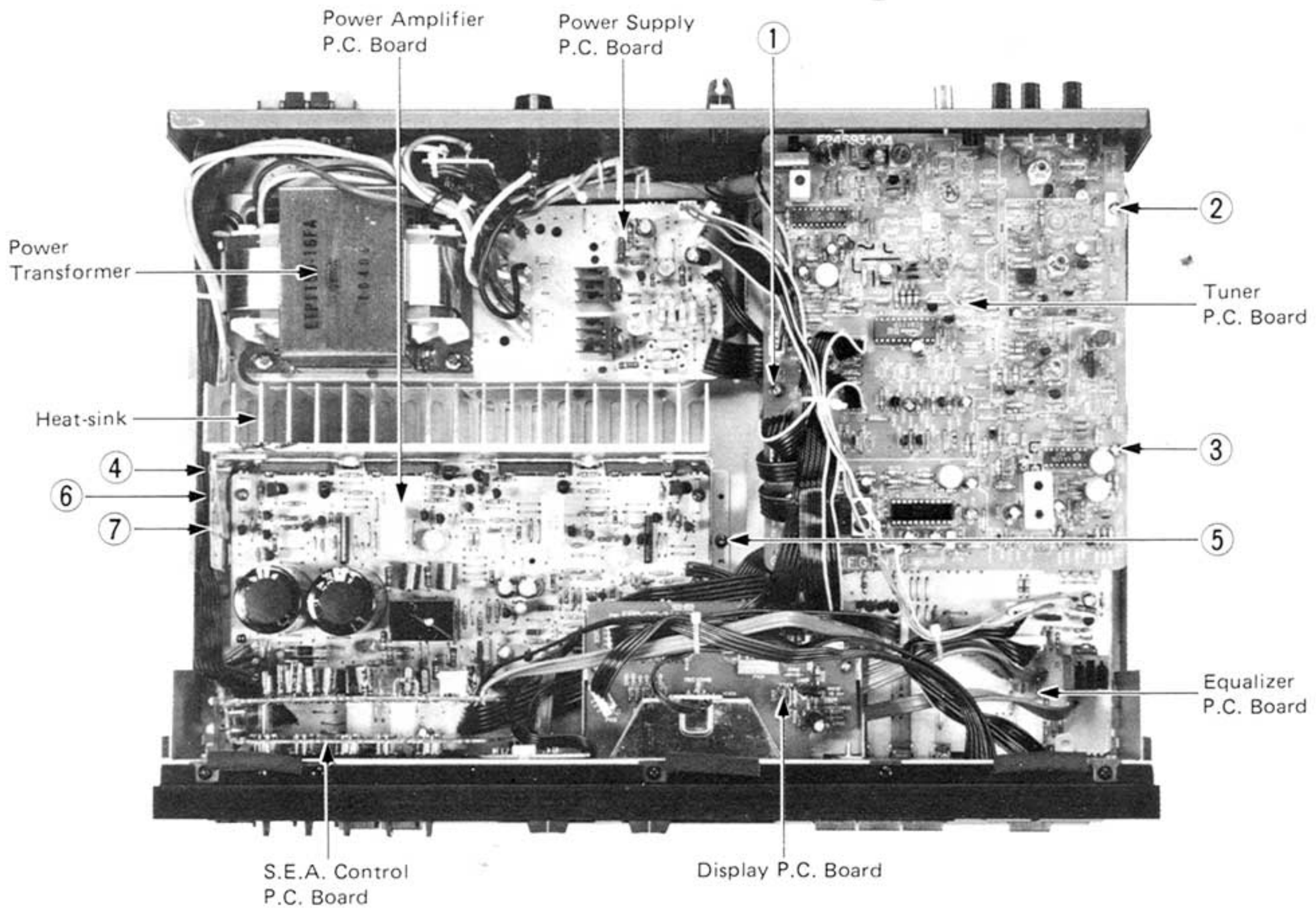

3-(1) Removing the Front Panel

- Step 1: Demount the top cover by removing four screws from the two sides and two screws from the rear.
- Step 2: Remove three screws securing the front panel on its upper side and three screws securing it on the lower side.
- Step 3: Demount the switch PC board secured to the front panel with catches.

3-(2) Removing the Tuner P.C. Board

- Step 1: Demount the top cover (see above item 3-(1), Step 1).
- Step 2: Remove three screws ① through ③ securing the tuner PC board on its upper side.
- Step 3: Remove three screws securing the antenna terminal on its rear side.

3-(3) Removing the Equalizer P.C. Board

- Step 1: Demount the tuner PC board (see above item 3-(2)).
- Step 2: Extract the four push-knobs.
- Step 3: Remove four screws securing the push switch on the front side.
- Step 4: Remove seven screws securing the pin jacks and other items on the rear side.
- Step 5: Remove six screws securing the rear panel on its bottom side.

3-(4) Removing the Display P.C. Board

- Step 1: Demount the top cover (see above item 3-(1), Step 1).
- Step 2: Remove two screws securing the display PC board.

3-(5) Removing the S.E.A. Control P.C. Board

- Step 1: Remove the front panel (see above item 3-(1)).
- Step 2: Remove five miniscrews securing the slide volume knob on the front side.

3-(6) Removing the Power Amplifier P.C. Board

- Step 1: Remove the front panel (see above item 3-(1)).
- Step 2: Remove screw ④ securing the wire protector (made of transparent plastic).
- Step 3: Remove screw ⑤ securing the heat-sink bracket on its upper side, as well as screw ⑥ securing it on its bottom side.
- Step 4: Cut off wire clamp ⑦ (NOTE: When assembling, do not forget to properly arrange the wires with the wire clamp).
- Step 5: Extract the two push-knobs.
- Step 6: Remove two screws securing the push switch on the front side.

4. Adjustment Procedures

4-(1) FM/AM Tuner

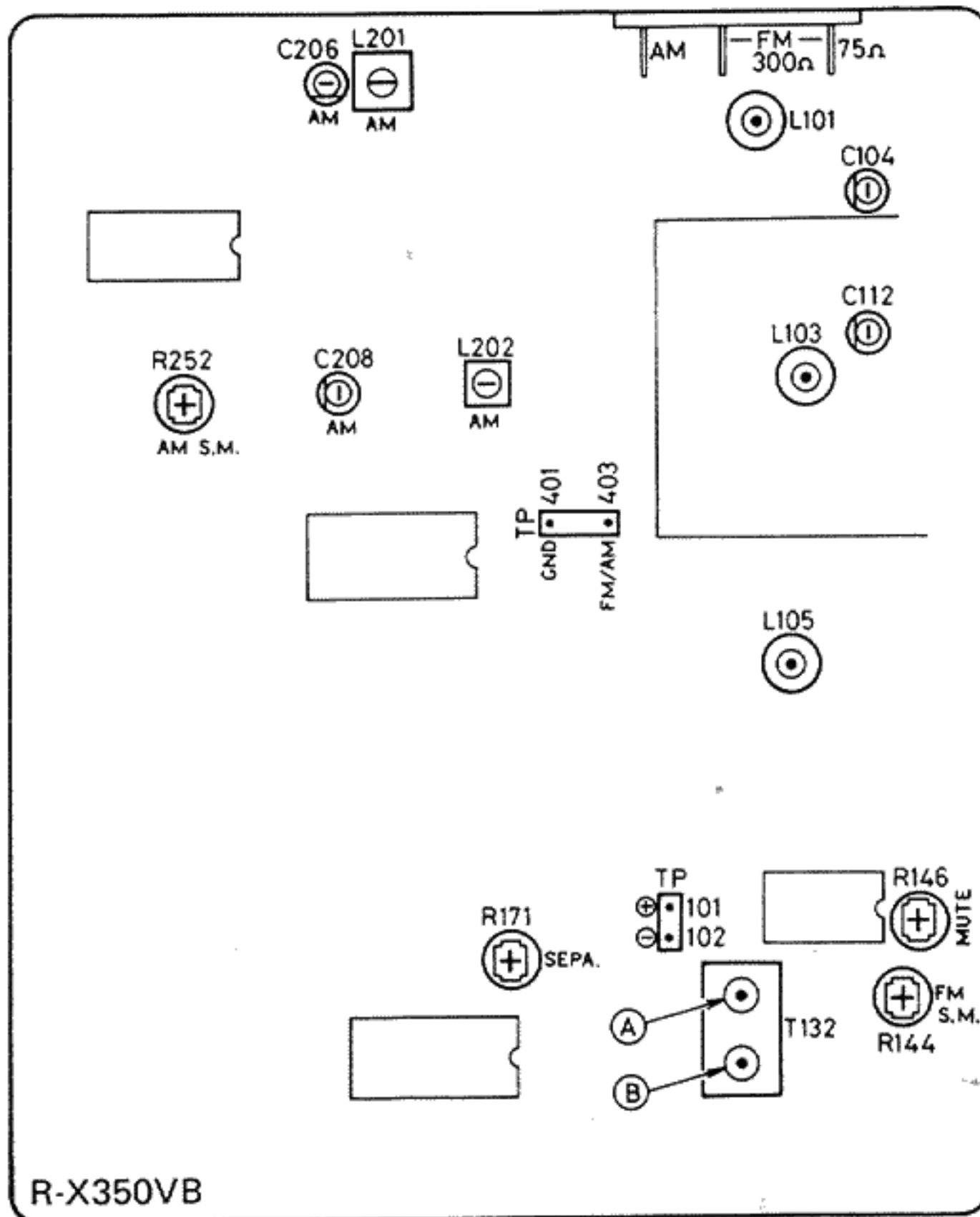

FM Section

Band Cover

1. Set the frequency display to 107.9 MHz.
2. Connect a DC VTVM to TP403 and TP401 (GND).
3. Adjust L105 so that the VTVM shows 9.00 V.
4. And set the frequency display to 87.9 MHz.
5. Check the VTVM voltage reading $1.7 \text{ V} \pm 0.5 \text{ V}$.

Sensitivity

Low Frequency

1. Connect an RF generator to the antenna terminals on the rear panel through a dummy antenna.
2. Set an RF generator to 90 MHz, a modulation of 1 kHz and a deviation of 75 kHz to provide an input of $2 \mu\text{V}$.
3. Connect a VTVM and an oscilloscope to the Rec. out jacks on the rear panel.
4. Set the frequency display to 90 MHz.
5. Adjust coils L101 and L103 to maximize the output.

High Frequency

6. Set the RF generator to 106 MHz, a modulation of 1 kHz and a deviation of 75 kHz to provide an input of $2 \mu\text{V}$.
7. Set the Frequency Display to 106 MHz.
8. Adjust the FM trimmers C104 and C112 to maximize the output.
9. Repeat these high and low frequencies adjustment alternately until maximum sensitivity is obtained.

Discriminator, Distortion and Signal Gain

1. Press to FM position.
2. Connect an RF generator, 1 kHz modulation and a 75 kHz deviation to the antenna terminals on the rear panel through a dummy antenna.
3. Connect an oscilloscope, Distortion Meter and VTVM to the Rec. out jacks on the rear panel.
4. Set the RF generator to 98 MHz, generator output to minimize.
5. Set the Frequency Display to a 98 MHz.
6. Connect a DC VTVM between TP101 and TP102.
7. Adjust the core indicated arrow (A) of T132 for DC VTVM reading of 0 (zero) mV.
8. And set the RF generator output to 1 mV.
9. Adjust the core indicated arrow (B) of T132 so that the distortion is minimized.

Stereo Separation

1. Switch the selector of stereo modulator to left channel modulation.
2. Adjust R171 so that the output of right channel is minimized.
3. Switch the selector of the modulator to right channel modulation.
4. Adjust R171 so that the left channel is minimized.
5. Set R171 to a average, if the separation of left and right is different.

FM Muting

1. Connect the RF generator to the antenna terminal on the rear panel.
2. Set the RF generator at 100.1 MHz, $5 \mu\text{V}$. Rotate R146 clockwise, and stop rotating at the point where muting is eliminated (signals are output).

FM-signal Strength Meter

3. Set the RF generator at 100.1 MHz, $100 \mu\text{V}$. While rotating R144 clockwise, adjust the FM-signal strength meter so that this meter displays 40 dB.

AM Section

Band Cover

1. Press to AM (MW) position.
2. Set the frequency display to 530 kHz (10 kHz channel step), or 522 kHz (9 kHz channel step).
3. Connect DC VTVM to TP403 and TP401 (GND).
4. Adjust L202 so that the VTVM shows 1.05 V (530 kHz), or 0.95 V (522 kHz).
5. And set the frequency display to 1710 kHz (10 kHz channel step), or 1611 kHz (9 kHz channel step).
6. Adjust C208 so that the DC VTVM reads 9.00 V for 1710 kHz, or 7.50 V for 1611 kHz.

Tracking and Sensitivity

1. Connect the RF generator to the antenna terminal on the rear panel.
2. Set the generator to 600 kHz (or 603 kHz) with 30 % modulation at 400 Hz.
3. Set the frequency display to 600 kHz, or 603 kHz.
4. Adjust L201 to maximize the output.
5. Set the generator to 1400 kHz, or 1404 kHz.
6. Set the frequency display of the unit to 1400 kHz, or 1404 kHz.
7. Adjust C206 so that the output signal is maximized.
8. Repeat these adjustments (1 ~ 7) alternately until maximum sensitivity is obtained.

AM-signal Strength Meter

1. Connect the RF generator to the antenna terminal on the rear panel. On this work, use the dummy antenna and achieve connection in series via 5.6 k Ω .
2. Set the RF generator either at 999 kHz (9 kHz step) or 1,000 kHz (10 kHz step), 1 mV.
3. While rotating R252 clockwise, adjust the AM-signal strength meter so that this meter displays 70 dB.

4-(2) Power Amplifier Idling Current

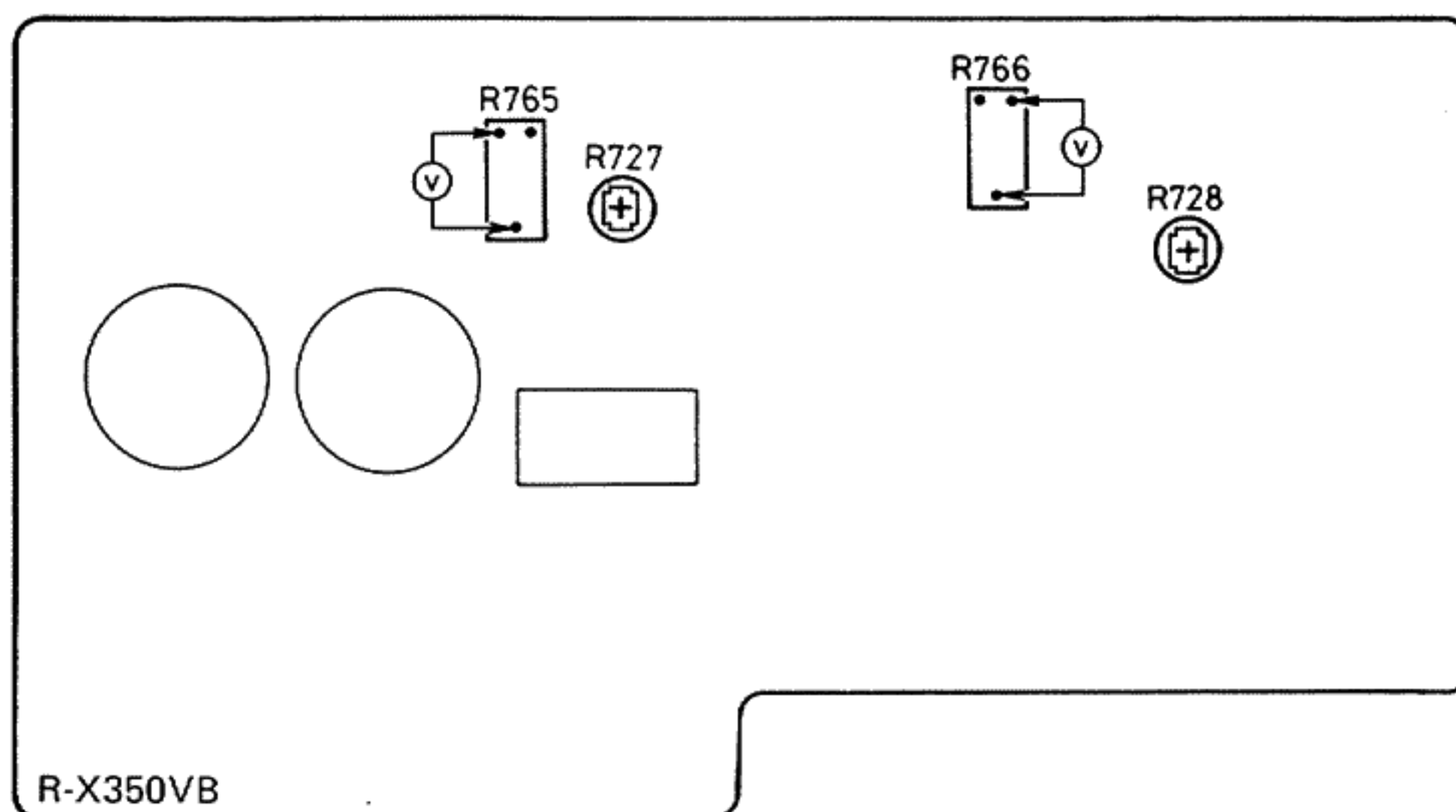

Precaution

1. Turn R727 and R728 fully counterclockwise before the power switch on.
2. Allow the set warm up at least 5 minutes before adjustment.
3. Must keep the heatsink to prevent overheating before adjustment.
4. Set the volume control to minimum during this adjustment.

Adjustment

5. Connect a DC VTVM to R765 resistor's leads for left channel, or to R766's leads for right channel.
6. Adjust R727 for left channel, or R728 for right channel, so that the DC VTVM reads 5 mV.

5. Block Diagram

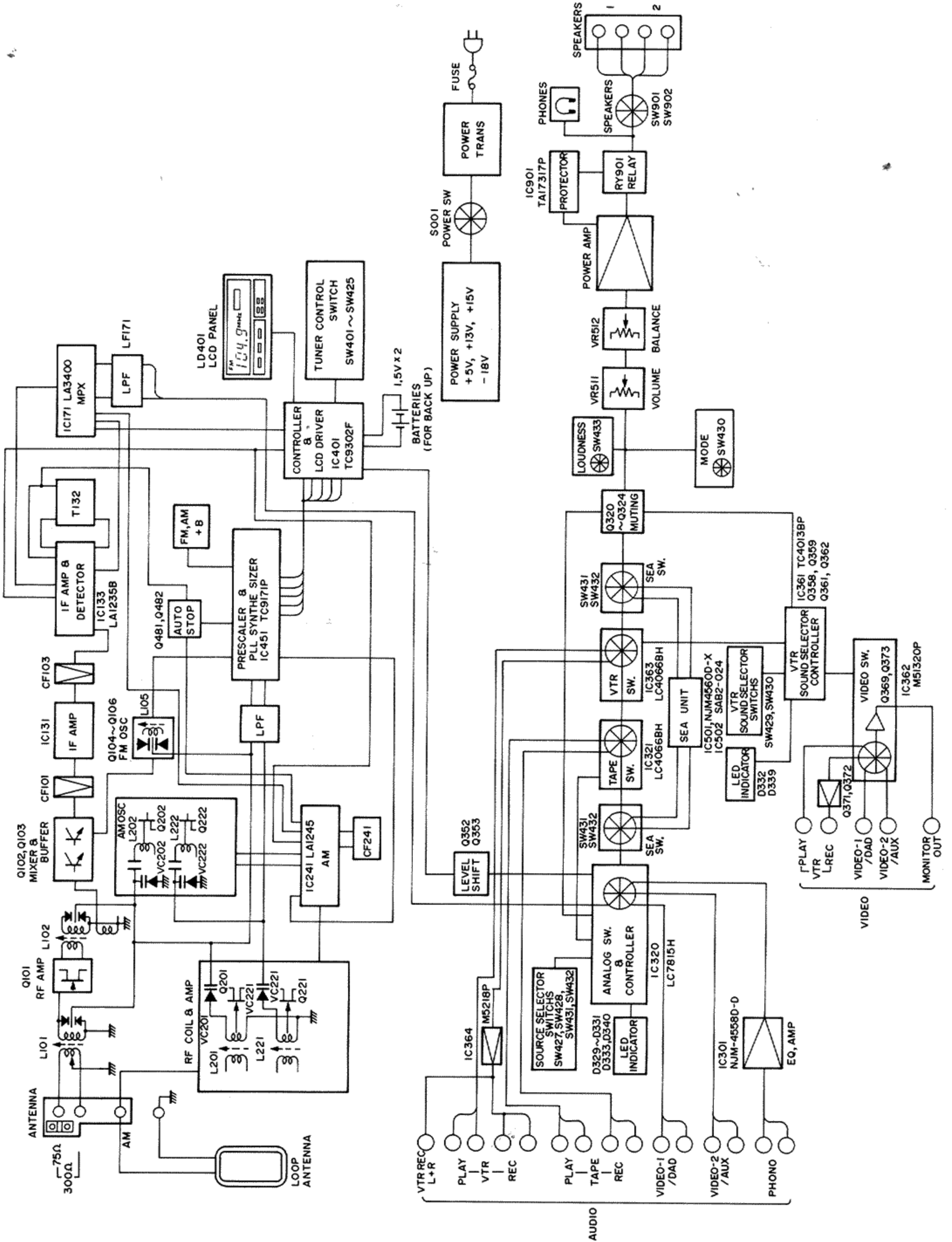

6. R-X350VB Schematic Diagram

6-(1) R-X350VB Tuner Section

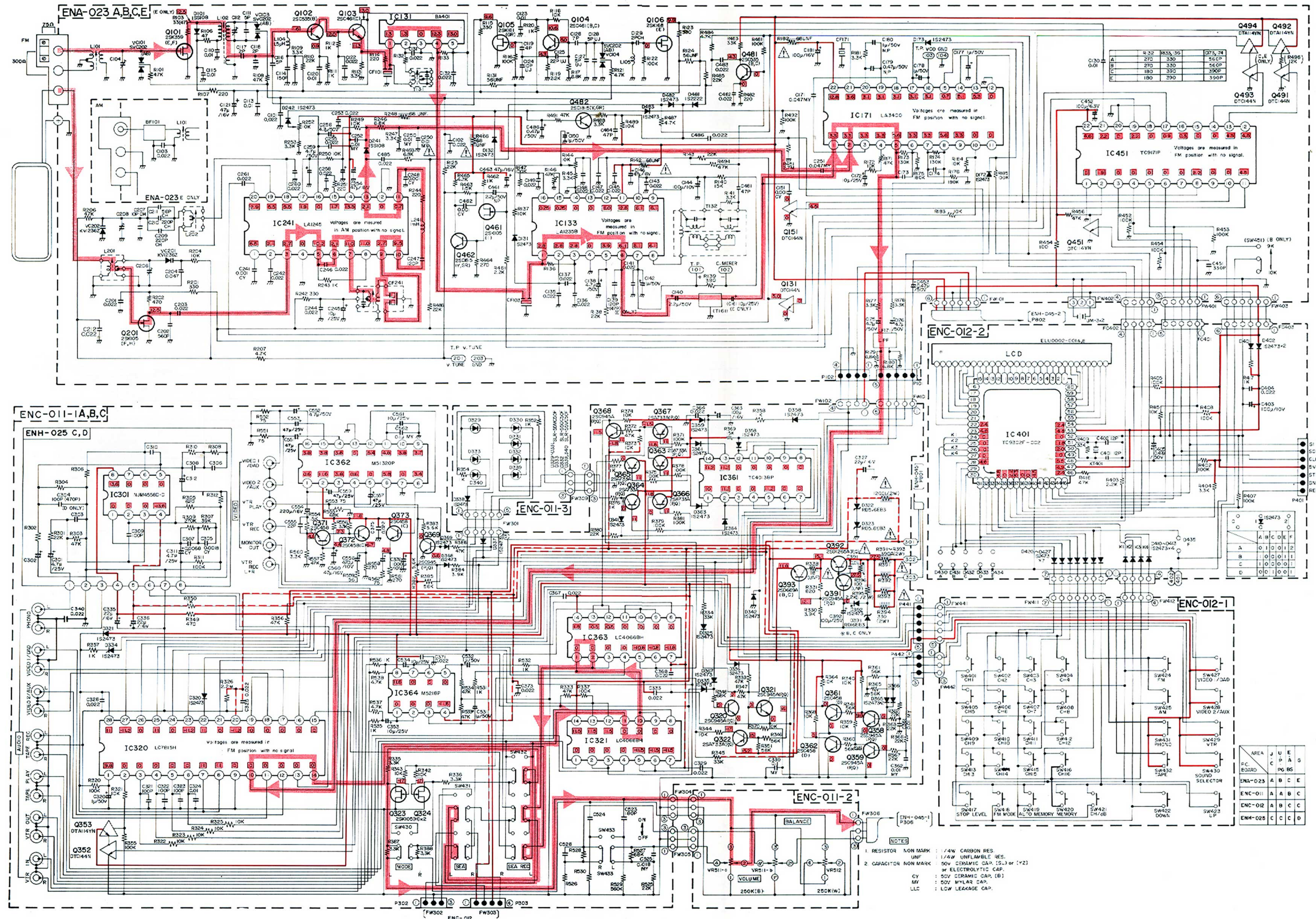

Notes:

1. shows DC voltage to the chassis with no signal input.
2. indicates positive B power supply.
3. indicates negative B power supply.
4. indicates signal path.

5. When replacing the parts in the darkened area () and those marked with , be sure to use the designated parts to ensure safety.
6. This is the standard circuit diagram. The design and contents are subject to change without notice.

6-(2)R-X350VB Amplifier Section

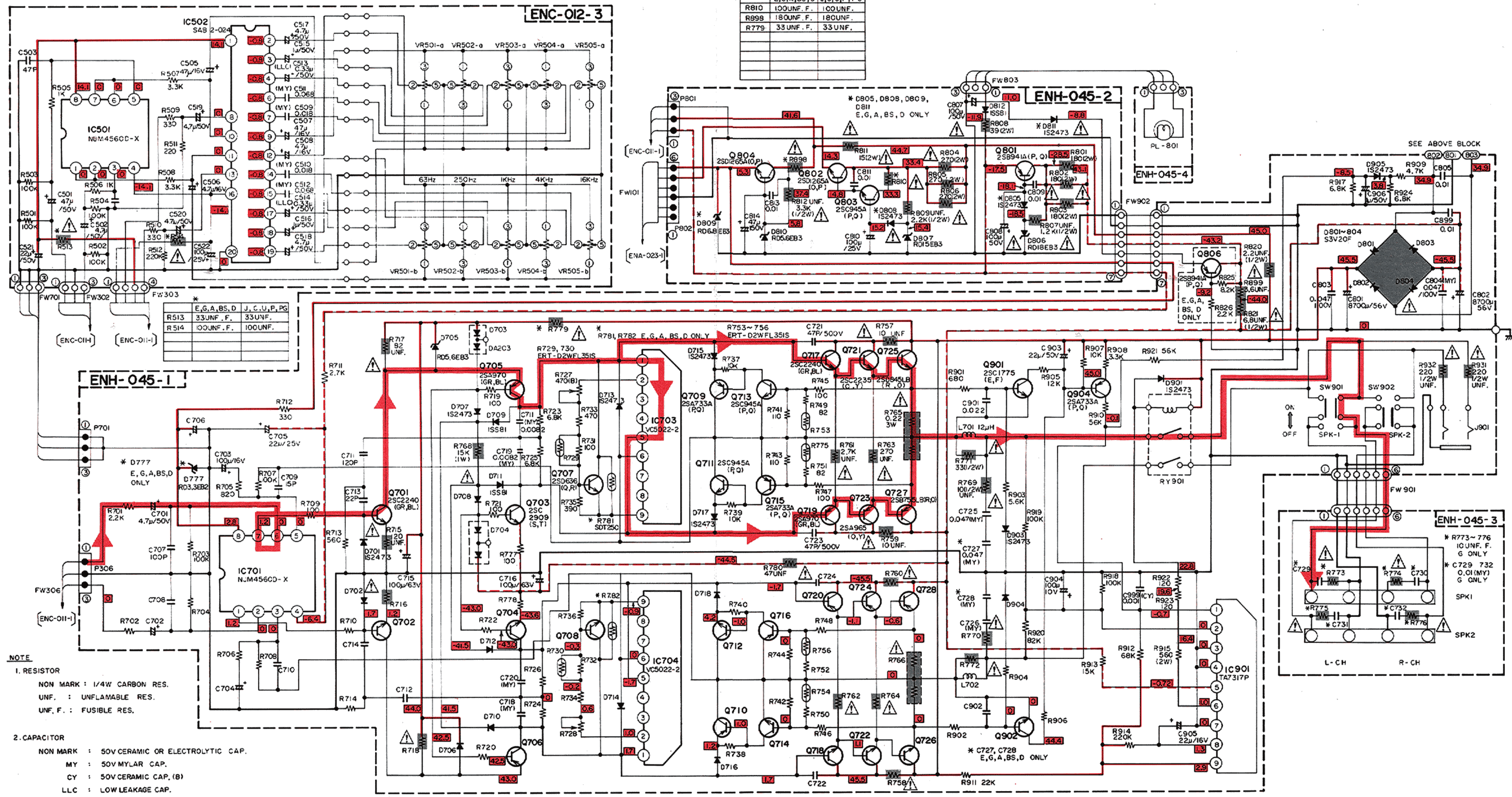
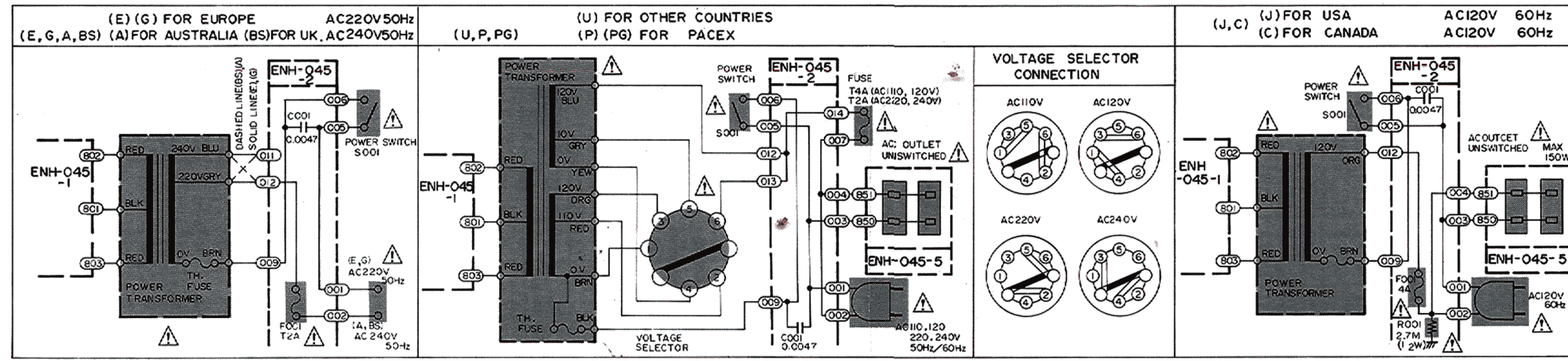

Notes:

1. shows DC voltage to the chassis with no signal input.
2. indicates positive B power supply.
3. indicates negative B power supply.
4. indicates signal path.

5. When replacing the parts in the darkened area () and those marked with , be sure to use the designated parts to ensure safety.
6. This is the standard circuit diagram.
The design and contents are subject to change without notice.

7. Servicing Method for AWG #20 Wires with Clamping Terminals

(1) Application objective \Rightarrow Confirmation of safety
 Used to prevent breakage/disconnection troubles of primary and secondary wires within PC boards (or between PC boards). Even when wire breakage/disconnection has actually occurred, a safe air-gap distance between the primary wire and the secondary wire/possibly contacting metal surface can be maintained because the terminal retains the wire sheathing.

(2) Type of wire used

- ① 1015 AWG-#20 (single-coated)
- ② 1672 AWG-#20 (double-coated)

(3) Servicing precautions

① The structural design of this terminal causes its catch to hook onto the PC board, preventing the wire from being easily pulled out. As shown in the figure, use cutting pliers or a similar tool to cut off the ends of the terminal and wire; then remove the remaining terminal clip by melting the soldering.

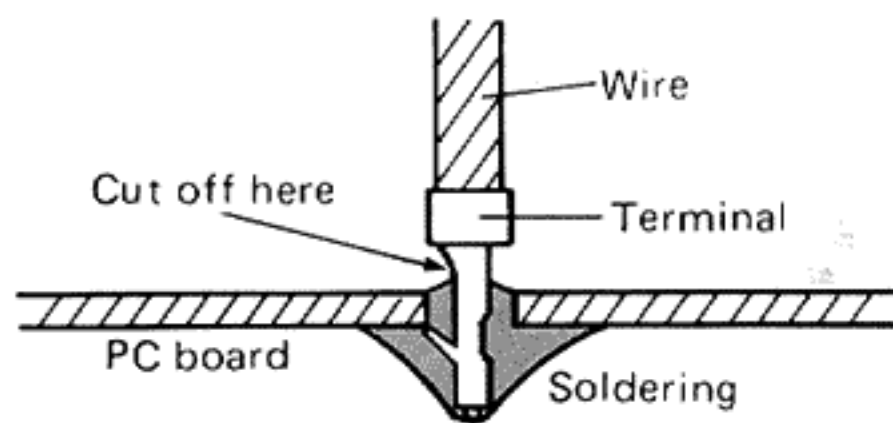

② Prior to soldering the wire onto the PC board, confirm safety by pressure-fitting the terminal to the wire by observing the following procedures.

1. Strip off the wire 5 ~ 6 mm from its end.

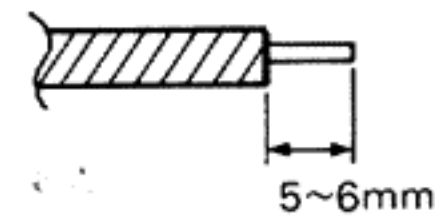

2. Insert the wire until its sheathing contacts section "A" of the terminal and pressure-fit the terminal clamp at three sections of (a), (b), and (c) (section (c) is especially important to assure safety. Exercise particular care to achieve secure clamping).

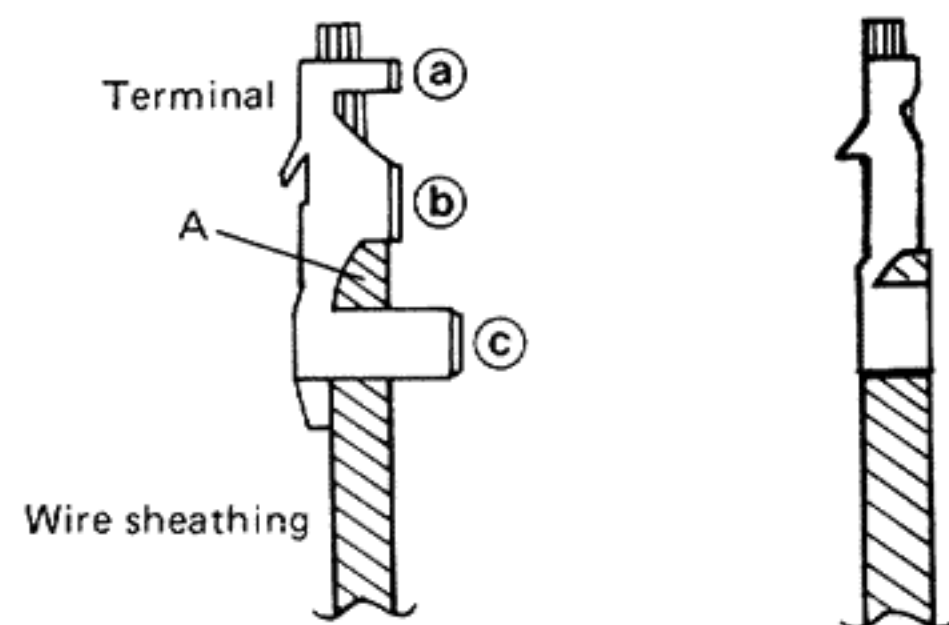

③ Part No., and name

Part No. : 5298T
 Name : CRIMP PIN

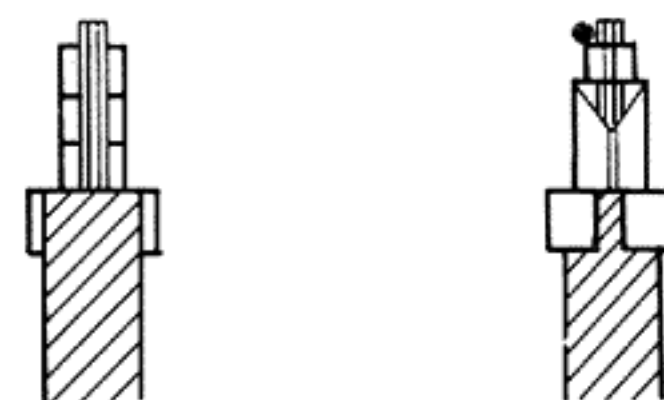

8. Handling precautions of LCD panels

The LCD (Liquid Crystal Display) panel employed in this device requires the following handling precautions.

1. Since the LCD is made of plate glass, never apply strong mechanical impact to it.

Do not forcibly press the light-polarizing plate.

When handling, grip it as shown in the figure below.

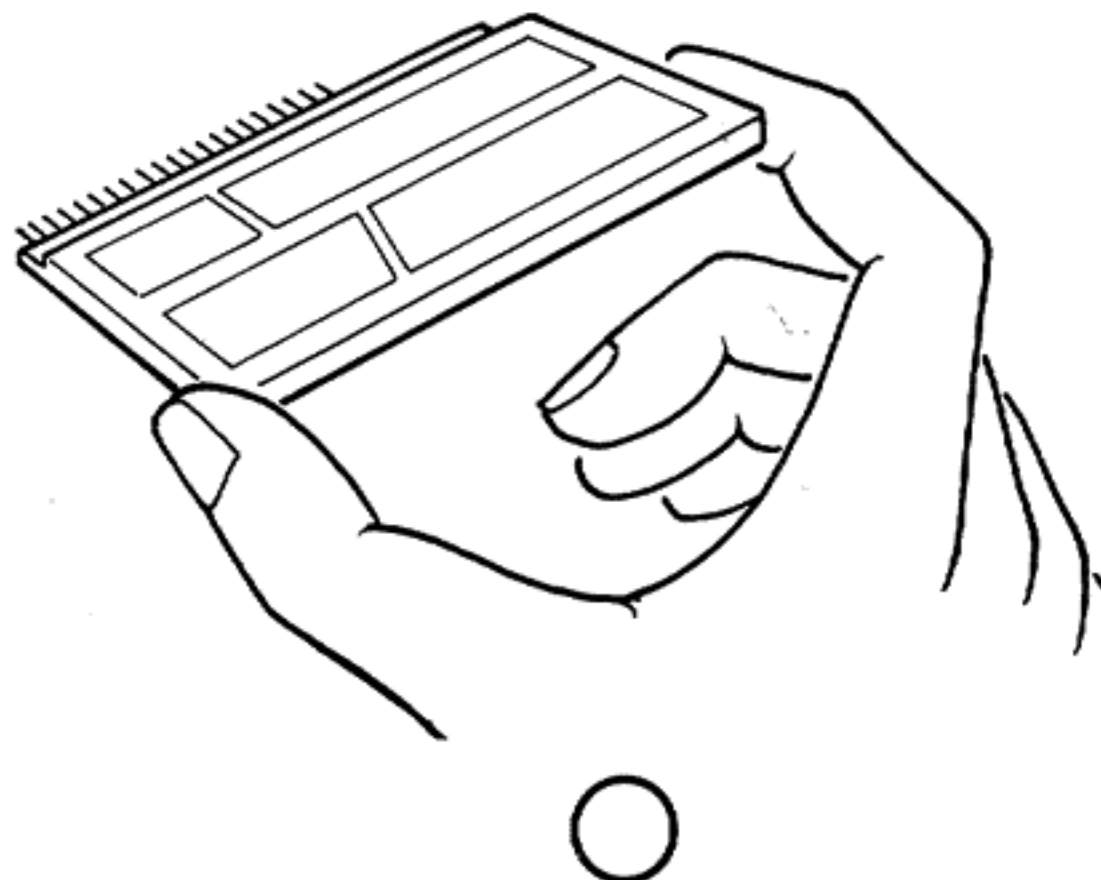
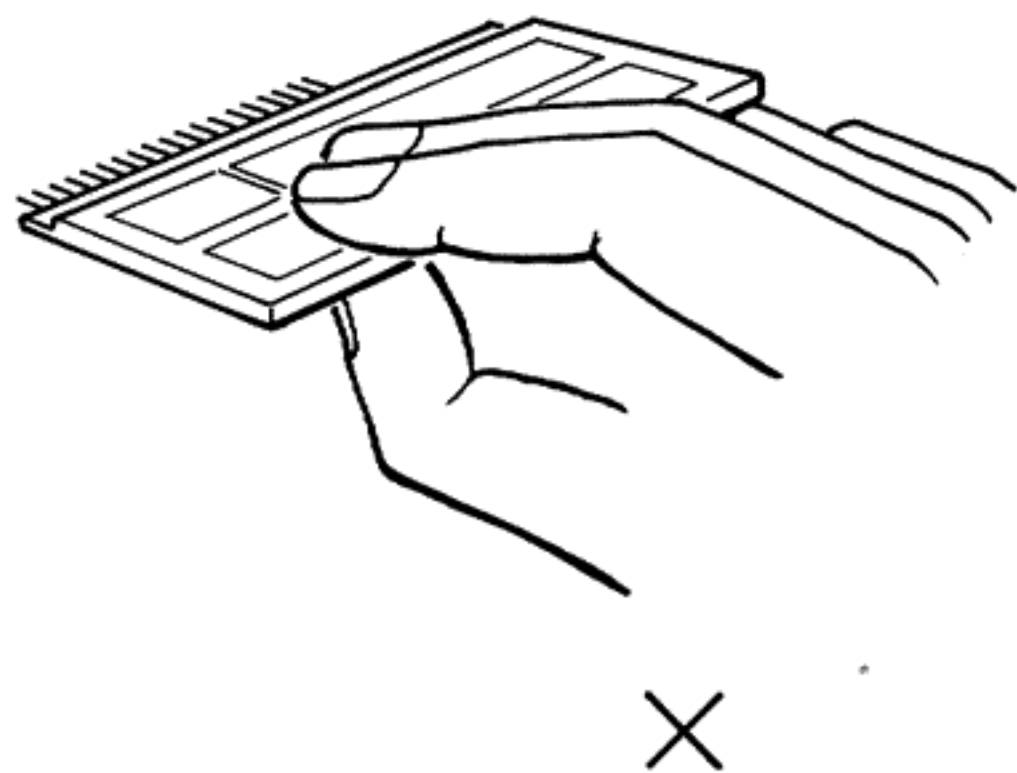

2. When handling the LCD, wear gloves whenever possible.
3. When the light-polarizing plate (surface other than silk-printed areas) becomes contaminated, use an applicator wet with isopropyl alcohol to gently wipe it clean. As for the silk-printed areas, use a soft cloth also to gently wipe it clean.
NOTE: The light-polarizing plate attached to the LCD surface and the silk-printed areas are made of soft material.
4. As much as possible, avoid exposing the LCD to irradiation of harmful light (direct sunlight or ultraviolet rays), especially when the device is not in use.
5. Do not imprint DC voltage on pins of the LCD (characteristics will be degraded).
6. When the LCD is damaged, resulting in leakage of liquid crystal, be very cautious to avoid the liquid from penetrating one's mouth or being swallowed. Should liquid crystal contact the hands or clothing, immediately wash with water, using soap or other appropriate cleanser.

JVC

VICTOR COMPANY OF JAPAN, LIMITED
STEREO DIVISION, YAMATO PLANT, 1644, SHIMOTSURUMA, YAMATO-SHI, KANAGAWA-KEN, 242, JAPAN